

Product Parts for HARDWARE (STEPS 1-5)

- 1 - Mural Graphic Face Plates (qty: 15)
- 2 - Mag Rails (qty: 5)
- 3 - Square Hard Case
- 4 - Frame
- 5 - Hardware Bag

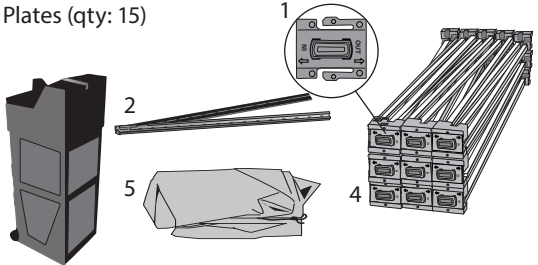

**Frame (3) should come with Face Plates already installed.

Product Parts for PANEL KIT and LIGHT

- 6 - Panels (see chart above for qty and panel style)
- 7 - LED light kit

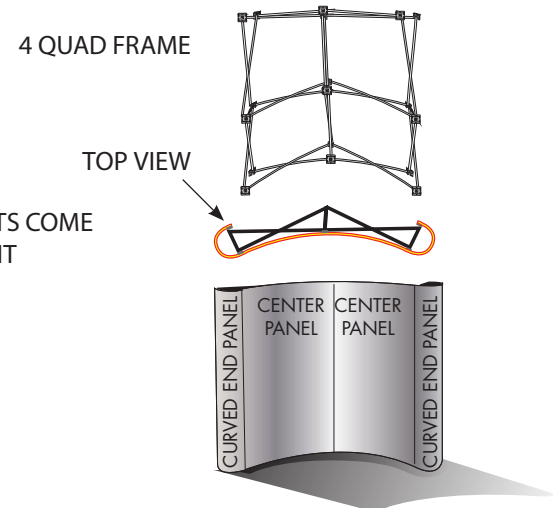

Display Set-Up

Step 1

Remove all parts from your Hard Case (3) and place on a flat, clean surface. Review the Frame (4) and notice where the pivoting light clips are located. This will determine the TOP of the display.

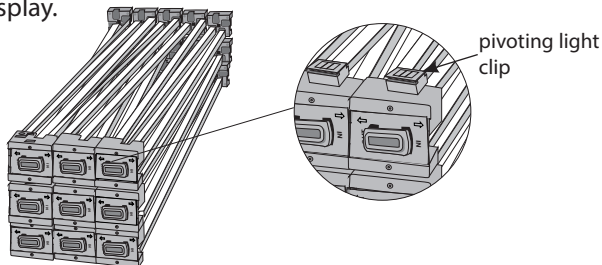

Step 2

Pull the Frame (4) up and out from the corners until it is fully expanded on the table.

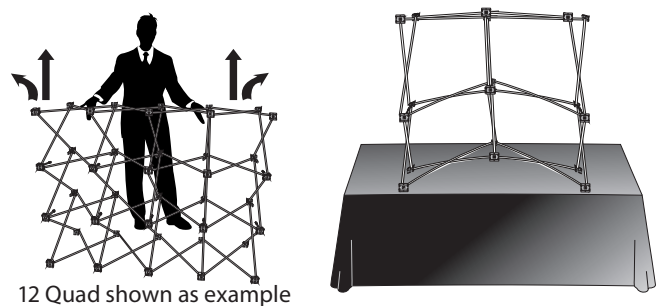

Step 3

Push all locking clips together to secure the Frame (4) in its expanded position.

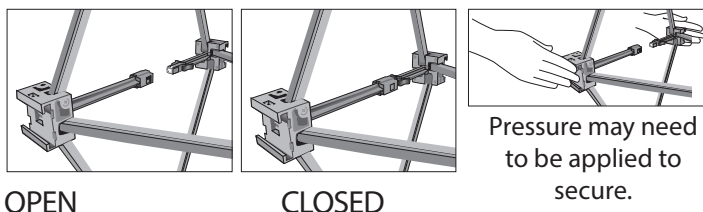

Step 4:

With 2-sectioned Mag Rail (2) folded, start with BOTTOM section and slide back slot onto Mural Graphic Face Plates (1) on Frame.

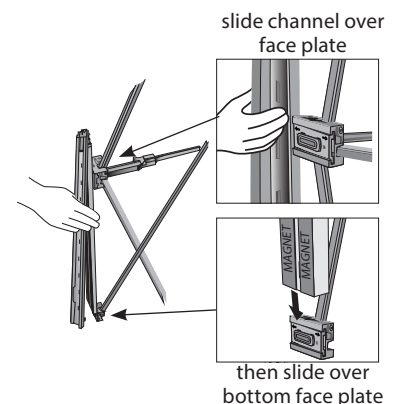

Display Set-Up Continued...

Step 5:

Unfold Mag Rail (2) and secure TOP section onto BOTTOM section. When done you will have Mag Rails (2) on all front connection points as well as on the back vertical ends.

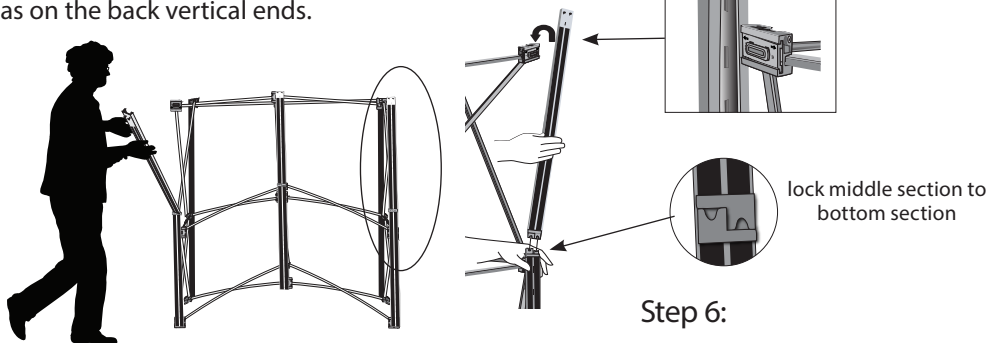

Step 6:

Universal Light Adapter for Pop-Ups

Insert the Light Fixture into the adapter (7a) and align the holes. Insert the quick release pin. Slide the adapter over the light clip on top of the frame.

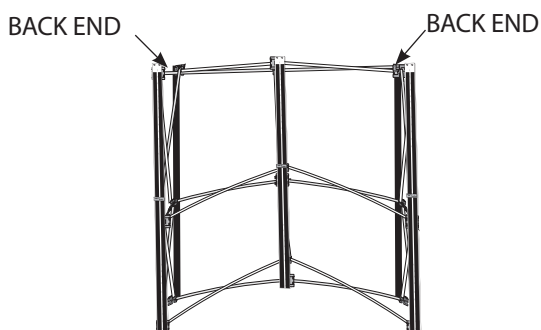

Step 7

Set all plastic wrapped panels (6) out on floor in order of how they will be installed. All panels are installed by hooking the notch located on the top of the panel (6) to the pins at the top of the mag rail.

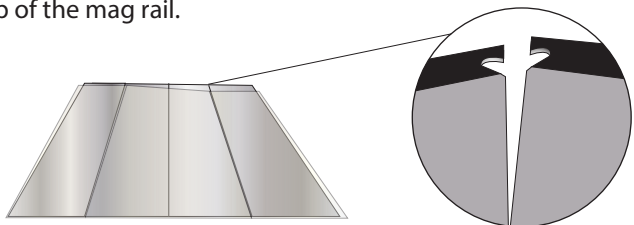

(KEEP the protective sleeves as they will be used for storage.)

Step 8

Install the Panels (6) to the Frame. Start with the end. Remove it from protective sleeve and while holding it in a curved position hook the notches located on top of the panel (6) to the pins at the top of front end and back end Mag Rail (2). With top notches both hooked slide your hands down the panel securing it to the vertical Magnets.

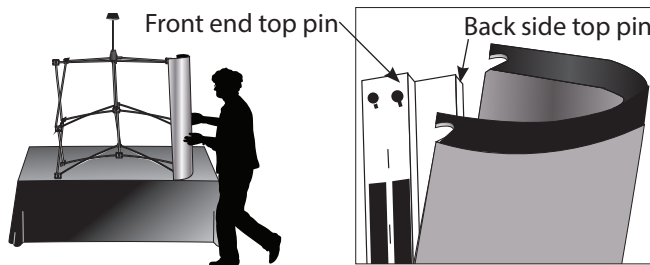

Step 9

Secure the rest of the panels using the same method as in Step 8.

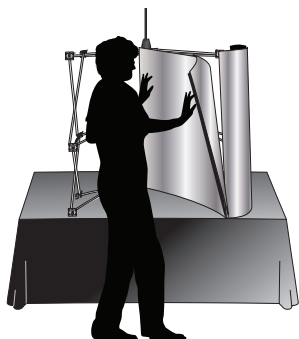

Step 10

Plug light (7) into power source. Display is now ready.

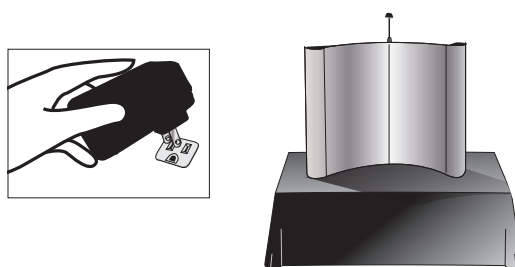

Disassembly Instructions

Step 1

Remove all Panels (6) and carefully roll them up graphic/fabric side out. Place into clear protective sleeves.

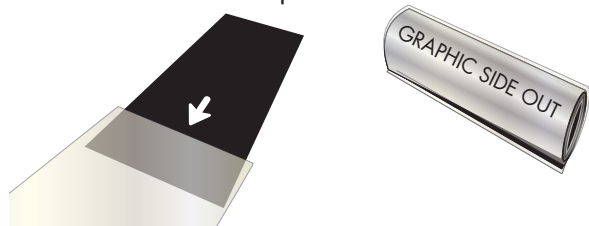

Step 2

Place rolled Panels (6) into Hard Case (3).



Step 3

Unplug and remove light kit (6) from Frame (5). Place in carrying case.



Step 4

Remove all Mag Rails (2) from Frame (4). Collapse and place in hardware bag (5)

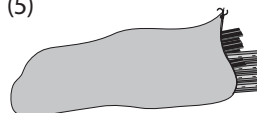

Step 5

Collapse Frame. **MAKE SURE ALL LOCKING CLIPS ARE IN OPEN POSITION** before collapsing Frame (4)

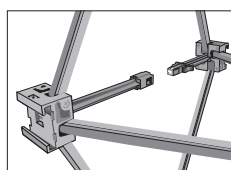

OPEN

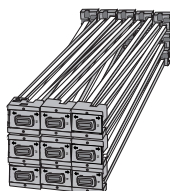

Step 6

Place all parts in the open center area inside the shipping case with rolled Panels (6).

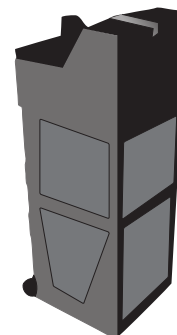

SET-UP NOTE:

Display should have Face Plates (1) already installed in Frame (4). If not, Slide (with force) the Face Plate (1) into the hubs. Typically you will slide RIGHT to LEFT when looking at the face of the Frame (4).

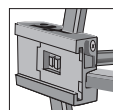
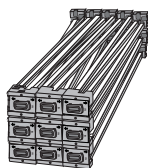

HUB

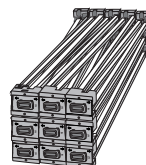
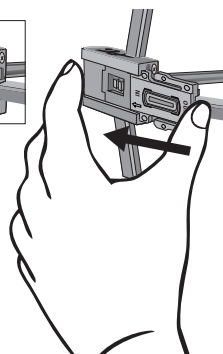

FRONT VIEW
(all hubs)

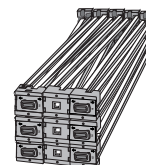

BACK VIEW
(vertical ends only)

See opposite for Face Plate Locations.

NOTE: FRAME HARDWARE HAS HUBS THAT CAN BE INTERCHANGED TO DISPLAY OTHER PRODUCTS
Conversion kits sold separately-contact client services for more details